

Solid Carbide Reamer

SumiReamer **SSR** series

Rewriting the Book
on Reamers



SumiReamer
SSR series

SSR-H7 Type

Internal Coolant Supply
ø3.0 to 12.0mm

SSR-J Type

Internal Coolant Supply
ø2.97 to 12.0mm



A balanced design combining sharpness and cutting edge strength, to achieve a high efficiency feed rate of = 1.6mm/rev!



■ Features

High efficiency and high-accuracy reaming achieved through excellent cutting edge quality and subtle right-hand helix flutes

Dedicated coating for reamers enables long and stable tool life

● Stable Hole Diameter

Optimized back taper design reduces frictional resistance with stable hole diameter finish through cutting action

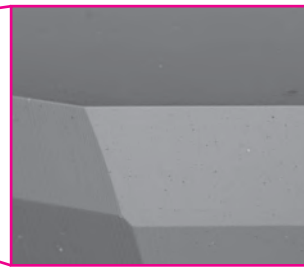

SSR series

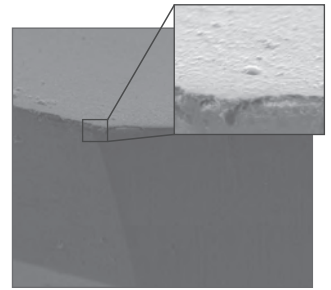

Conventional

● Smooth Chip Evacuation

A balanced design that combines sharpness and cutting edge strength with subtle right-handed helix flutes.



SSR series

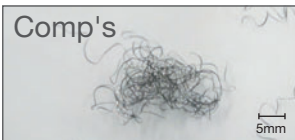

Comp's

Work Material: S50C
Tool: Diameter ø8mm
Cutting Conditions:
 $v_c=120\text{m/min}$, $f=1.2\text{mm/rev}$

Work Material: S50C
Tool: Diameter ø8mm
Cutting Conditions:
 $v_c=20\text{m/min}$, $f=0.09\text{mm/rev}$

● High Accuracy Reaming

Excellent cutting edge quality free of microchipping realizes good hole surface quality

● Long and Stable Tool Life - Dedicated Coating for Reamers

High quality, high hardness, high strength and excellent wear resistance and thermal resistance.

● Coolant Mechanism by Application

For Blind Holes (Center Coolant)

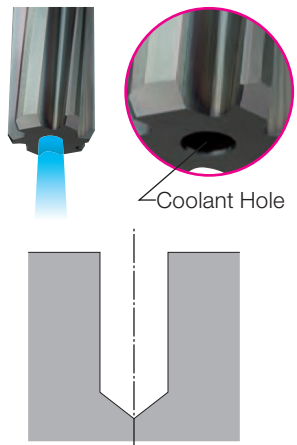

For Through Holes

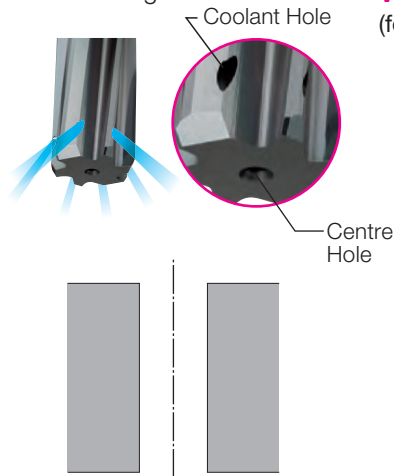

Unique coolant supply mechanism which does not hamper chip evacuation (for through holes)

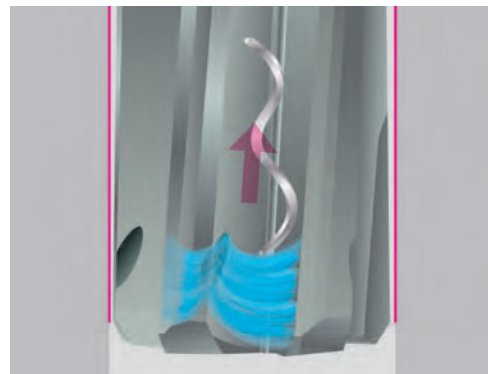

Coolant is supplied to the cutting edge from the flank side through the hole inner wall, achieving smooth chip evacuation without obstruction

■ Cutting Performance

- **Machining Efficiency Comparison**
 Realizes machining efficiency 60 times higher or more
An hour of machining reduced to a minute

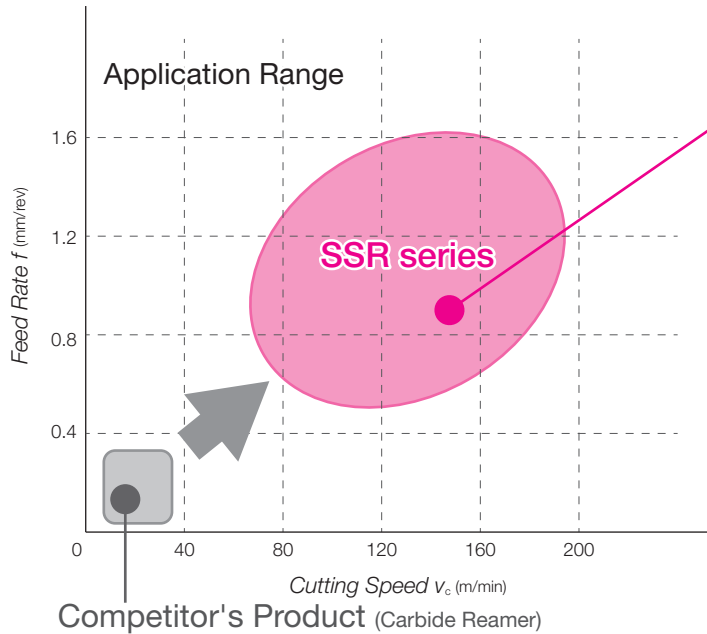

- **Reaming Precision**

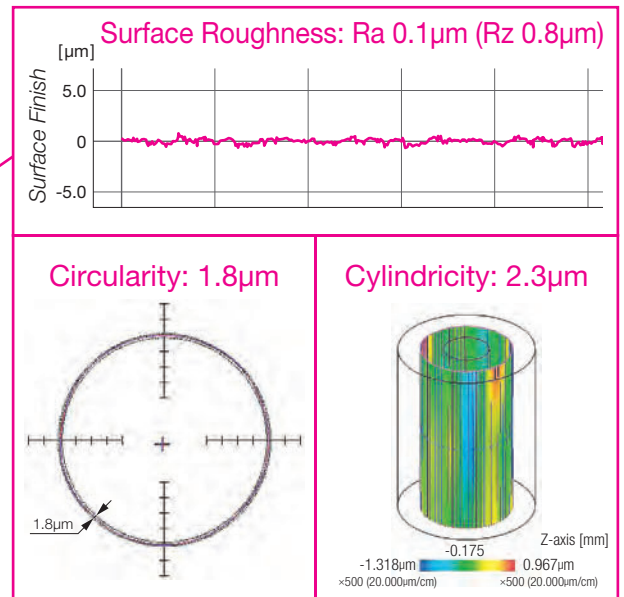

- **Tool Life Comparison**

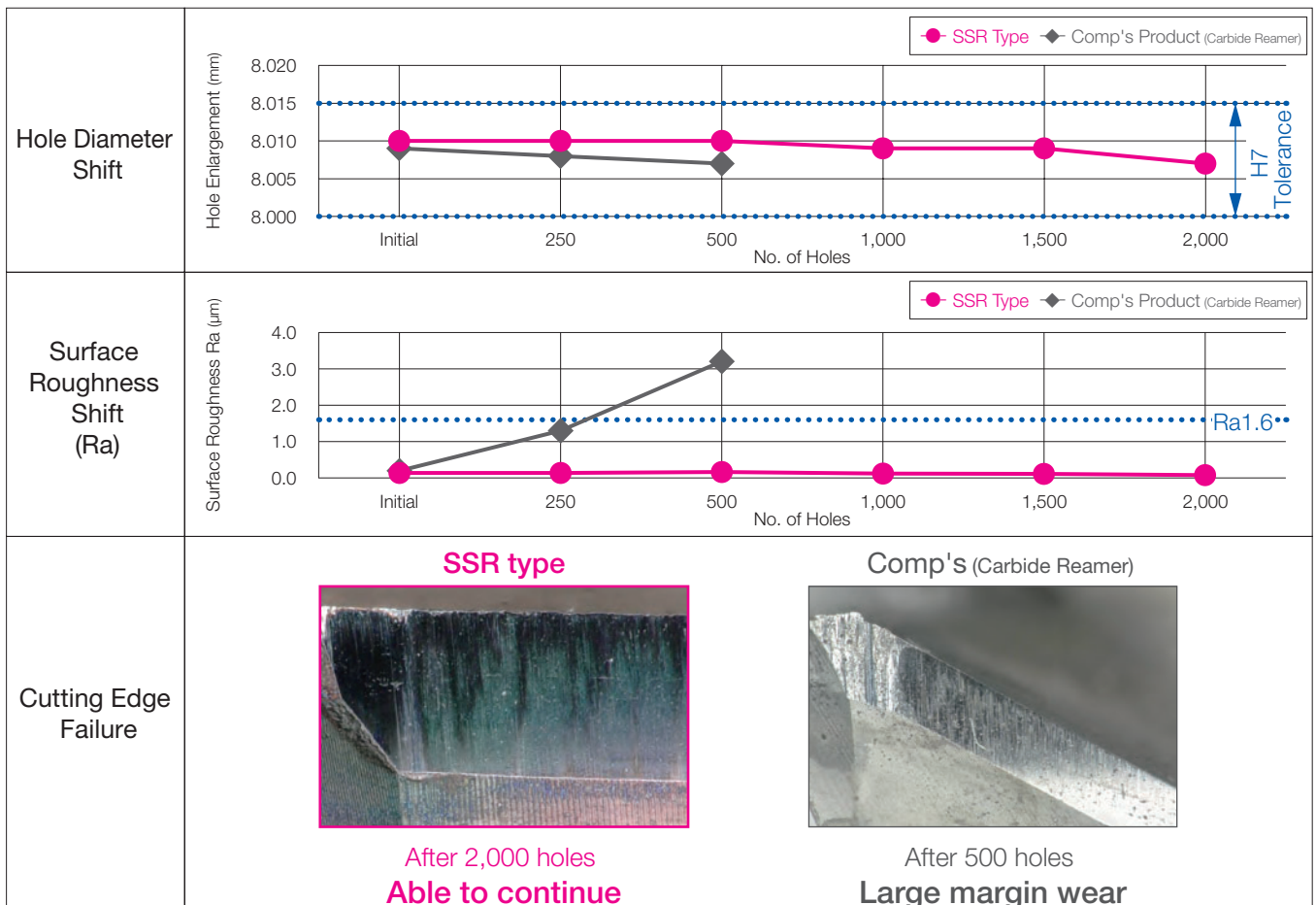

Machine: BT30 (internal coolant supply) Work Material: S50C Tool: SSR08000H7S (ø8mm H7 tolerance $H = 16$ mm)
 Cutting Conditions: **SSR type** $v_c = 150$ m/min, $f = 0.90$ mm/rev, $v_f = 5,374$ mm/min, $a_p = 0.1$ mm (depth of cut/radius)
 Competitor's Product $v_c = 15$ m/min, $f = 0.15$ mm/rev, $v_f = 89.6$ mm/min, $a_p = 0.1$ mm (depth of cut/radius)

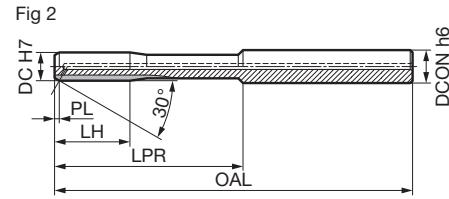
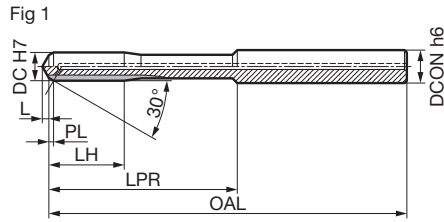

■ Diameter ø3.0 to 12.0mm

Diameter DC (mm)	Diameter Tolerance (mm)	Stock	Cat. No.	Dimensions (mm)						Number of Teeth	Fig
				Overall Length OAL	Shank Dia. DCON	Neck Length LPR	Cutting Edge Length LH	Engagement Length PL	Tip L		
3.0	+0.008 +0.004	●	SSR 03000H7T	68	4	40	12	0.5	0.7	4	1
3.5		●	SSR 03500H7T	68	4	40	12	0.5	0.9	4	1
4.0		●	SSR 04000H7T	76	5	40	12	0.5	1.0	4	1
4.5	+0.010	●	SSR 04500H7T	76	5	40	12	0.5	1.2	4	1
5.0	+0.005	●	SSR 05000H7T	76	6	40	12	0.5	1.3	4	1
5.5		●	SSR 05500H7T	76	6	40	12	0.5	1.5	4	1
6.0		●	SSR 06000H7T	76	7	40	16	1.0	—	4	2
6.5		●	SSR 06500H7T	76	7	40	16	1.0	—	4	2
7.0		●	SSR 07000H7T	101	8	65	16	1.0	—	6	2
7.5		●	SSR 07500H7T	101	8	65	16	1.0	—	6	2
8.0	+0.012	●	SSR 08000H7T	101	9	65	19	1.0	—	6	2
8.5	+0.006	●	SSR 08500H7T	101	9	65	19	1.0	—	6	2
9.0		●	SSR 09000H7T	101	10	65	19	1.0	—	6	2
9.5		●	SSR 09500H7T	101	10	65	19	1.0	—	6	2
10.0		●	SSR 10000H7T	130	11	85	22	1.0	—	6	2
10.5		●	SSR 10500H7T	130	11	85	22	1.0	—	6	2
11.0	+0.015	●	SSR 11000H7T	130	12	85	22	1.0	—	6	2
11.5	+0.008	●	SSR 11500H7T	130	12	85	22	1.0	—	6	2
12.0		●	SSR 12000H7T	130	13	85	22	1.0	—	6	2

Grade: ACR40

Recommended Cutting Conditions **P8**

■ Identification Code

SSR 03500 H7T

Series

Dia.

Reaming Hole Tolerance
for Through Holes

Fig 1

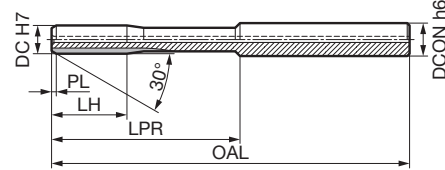

■ Diameter ø3.0 to 12.0mm

Diameter DC (mm)	Diameter Tolerance (mm)	Stock	Cat. No.	Dimensions (mm)					Number of Teeth	Fig
				Overall Length OAL	Shank Dia. DCON	Neck Length LPR	Cutting Edge Length LH	Engagement Length PL		
3.0	+0.008 +0.004	●	SSR 03000H7S	68	4	40	12	0.5	4	1
3.5		●	SSR 03500H7S	68	4	40	12	0.5	4	1
4.0		●	SSR 04000H7S	76	5	40	12	0.5	4	1
4.5	+0.010	●	SSR 04500H7S	76	5	40	12	0.5	4	1
5.0	+0.005	●	SSR 05000H7S	76	6	40	12	0.5	4	1
5.5		●	SSR 05500H7S	76	6	40	12	0.5	4	1
6.0		●	SSR 06000H7S	76	7	40	16	1.0	4	1
6.5		●	SSR 06500H7S	76	7	40	16	1.0	4	1
7.0		●	SSR 07000H7S	101	8	65	16	1.0	6	1
7.5		●	SSR 07500H7S	101	8	65	16	1.0	6	1
8.0	+0.012	●	SSR 08000H7S	101	9	65	19	1.0	6	1
8.5	+0.006	●	SSR 08500H7S	101	9	65	19	1.0	6	1
9.0		●	SSR 09000H7S	101	10	65	19	1.0	6	1
9.5		●	SSR 09500H7S	101	10	65	19	1.0	6	1
10.0		●	SSR 10000H7S	130	11	85	22	1.0	6	1
10.5		●	SSR 10500H7S	130	11	85	22	1.0	6	1
11.0	+0.015	●	SSR 11000H7S	130	12	85	22	1.0	6	1
11.5	+0.008	●	SSR 11500H7S	130	12	85	22	1.0	6	1
12.0		●	SSR 12000H7S	130	13	85	22	1.0	6	1

Grade: ACR40

Recommended Cutting Conditions **P8**

■ Identification Code

SSR 03500 H7S

Series

Dia.

Reaming Hole Tolerance
for Blind Holes

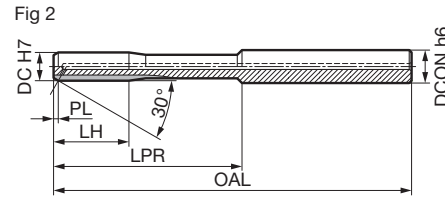
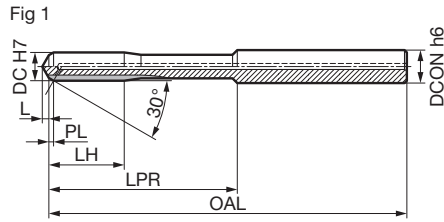

■ Diameter ø2.97 to 8.99mm

Diameter DC (mm)	Diameter Tolerance (mm)	Stock	Cat. No.	Dimensions (mm)						Number of Teeth	Fig	
				OAL	DCON	LPR	LH	PL	L			
2.97	+0.005 0	●	SSR 02970JT	68	4	40	12	0.5	0.7	4	1	
2.98		●	SSR 02980JT	68	4	40	12	0.5	0.7	4	1	
2.99		●	SSR 02990JT	68	4	40	12	0.5	0.7	4	1	
3.00	+0.005 0	●	SSR 03000JT	68	4	40	12	0.5	0.7	4	1	
3.01		●	SSR 03010JT	68	4	40	12	0.5	0.8	4	1	
3.02		●	SSR 03020JT	68	4	40	12	0.5	0.8	4	1	
3.03		●	SSR 03030JT	68	4	40	12	0.5	0.8	4	1	
3.97		●	SSR 03970JT	76	5	40	12	0.5	1.0	4	1	
3.98		●	SSR 03980JT	76	5	40	12	0.5	1.0	4	1	
3.99		●	SSR 03990JT	76	5	40	12	0.5	1.0	4	1	
4.00		+0.005 0	●	SSR 04000JT	76	5	40	12	0.5	1.0	4	1
4.01			●	SSR 04010JT	76	5	40	12	0.5	1.0	4	1
4.02	●		SSR 04020JT	76	5	40	12	0.5	1.0	4	1	
4.03	●		SSR 04030JT	76	5	40	12	0.5	1.0	4	1	
4.97	●		SSR 04970JT	76	6	40	12	0.5	1.3	4	1	
4.98	●		SSR 04980JT	76	6	40	12	0.5	1.3	4	1	
4.99	●		SSR 04990JT	76	6	40	12	0.5	1.3	4	1	
5.00	+0.005 0		●	SSR 05000JT	76	6	40	12	0.5	1.3	4	1
5.01			●	SSR 05010JT	76	6	40	12	0.5	1.3	4	1
5.02		●	SSR 05020JT	76	6	40	12	0.5	1.3	4	1	
5.03		●	SSR 05030JT	76	6	40	12	0.5	1.3	4	1	
5.97		●	SSR 05970JT	76	7	40	16	1.0	—	4	2	
5.98		●	SSR 05980JT	76	7	40	16	1.0	—	4	2	
5.99		●	SSR 05990JT	76	7	40	16	1.0	—	4	2	
6.00		+0.005 0	●	SSR 06000JT	76	7	40	16	1.0	—	4	2
6.01			●	SSR 06010JT	76	7	40	16	1.0	—	4	2
6.02	●		SSR 06020JT	76	7	40	16	1.0	—	4	2	
6.03	●		SSR 06030JT	76	7	40	16	1.0	—	4	2	
6.97	●		SSR 06970JT	101	8	65	16	1.0	—	6	2	
6.98	●		SSR 06980JT	101	8	65	16	1.0	—	6	2	
6.99	●	SSR 06990JT	101	8	65	16	1.0	—	6	2		
7.00	+0.005 0	●	SSR 07000JT	101	8	65	16	1.0	—	6	2	
7.01		●	SSR 07010JT	101	8	65	16	1.0	—	6	2	
7.02		●	SSR 07020JT	101	8	65	16	1.0	—	6	2	
7.03		●	SSR 07030JT	101	8	65	16	1.0	—	6	2	
7.97		●	SSR 07970JT	101	9	65	19	1.0	—	6	2	
7.98		●	SSR 07980JT	101	9	65	19	1.0	—	6	2	
7.99		●	SSR 07990JT	101	9	65	19	1.0	—	6	2	
8.00		+0.005 0	●	SSR 08000JT	101	9	65	19	1.0	—	6	2
8.01			●	SSR 08010JT	101	9	65	19	1.0	—	6	2
8.02	●		SSR 08020JT	101	9	65	19	1.0	—	6	2	
8.03	●		SSR 08030JT	101	9	65	19	1.0	—	6	2	
8.97	●		SSR 08970JT	101	10	65	19	1.0	—	6	2	
8.98	●		SSR 08980JT	101	10	65	19	1.0	—	6	2	
8.99	●		SSR 08990JT	101	10	65	19	1.0	—	6	2	

Grade: ACR40

■ Diameter ø9.00 to 12.00mm

Diameter DC (mm)	Diameter Tolerance (mm)	Stock	Cat. No.	Dimensions (mm)						Number of Teeth	Fig	
				OAL	DCON	LPR	LH	PL	L			
9.00	+0.005 0	●	SSR 09000JT	101	10	65	19	1.0	—	6	2	
9.01		●	SSR 09010JT	101	10	65	19	1.0	—	6	2	
9.02		●	SSR 09020JT	101	10	65	19	1.0	—	6	2	
9.03		●	SSR 09030JT	101	10	65	19	1.0	—	6	2	
9.97		●	SSR 09970JT	130	11	85	22	1.0	—	6	2	
9.98		●	SSR 09980JT	130	11	85	22	1.0	—	6	2	
9.99		●	SSR 09990JT	130	11	85	22	1.0	—	6	2	
10.00		+0.005 0	●	SSR 10000JT	130	11	85	22	1.0	—	6	2
10.01			●	SSR 10010JT	130	11	85	22	1.0	—	6	2
10.02	●		SSR 10020JT	130	11	85	22	1.0	—	6	2	
10.03	●		SSR 10030JT	130	11	85	22	1.0	—	6	2	
10.97	●		SSR 10970JT	130	12	85	22	1.0	—	6	2	
10.98	●		SSR 10980JT	130	12	85	22	1.0	—	6	2	
10.99	●		SSR 10990JT	130	12	85	22	1.0	—	6	2	
11.00	+0.005 0		●	SSR 11000JT	130	12	85	22	1.0	—	6	2
11.01			●	SSR 11010JT	130	12	85	22	1.0	—	6	2
11.02		●	SSR 11020JT	130	12	85	22	1.0	—	6	2	
11.03		●	SSR 11030JT	130	12	85	22	1.0	—	6	2	
11.97		●	SSR 11970JT	130	13	85	22	1.0	—	6	2	
11.98		●	SSR 11980JT	130	13	85	22	1.0	—	6	2	
11.99		●	SSR 11990JT	130	13	85	22	1.0	—	6	2	
12.00		●	SSR 12000JT	130	13	85	22	1.0	—	6	2	

Grade: ACR40

Recommended Cutting Conditions **P8**

■ Identification Code

SSR 03500 JT

Series Dia. For Through Holes

Fig 1

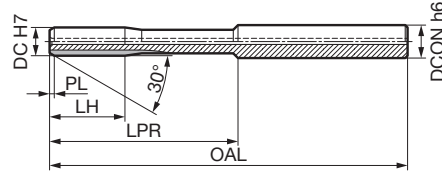

■ Diameter ø2.97 to 8.99mm

Diameter DC (mm)	Diameter Tolerance (mm)	Stock	Cat. No.	Dimensions (mm)					Number of Teeth	Fig	
				Overall Length OAL	Shank Dia. DCON	Neck Length LPR	Cutting Edge Length LH	Engagement Length PL			
2.97	+0.005 0	●	SSR 02970JS	68	4	40	12	0.5	4	1	
2.98		●	SSR 02980JS	68	4	40	12	0.5	4	1	
2.99		●	SSR 02990JS	68	4	40	12	0.5	4	1	
3.00	+0.005 0	●	SSR 03000JS	68	4	40	12	0.5	4	1	
3.01		●	SSR 03010JS	68	4	40	12	0.5	4	1	
3.02		●	SSR 03020JS	68	4	40	12	0.5	4	1	
3.03		●	SSR 03030JS	68	4	40	12	0.5	4	1	
3.97		●	SSR 03970JS	76	5	40	12	0.5	4	1	
3.98		●	SSR 03980JS	76	5	40	12	0.5	4	1	
3.99		●	SSR 03990JS	76	5	40	12	0.5	4	1	
4.00		+0.005 0	●	SSR 04000JS	76	5	40	12	0.5	4	1
4.01			●	SSR 04010JS	76	5	40	12	0.5	4	1
4.02	●		SSR 04020JS	76	5	40	12	0.5	4	1	
4.03	●		SSR 04030JS	76	5	40	12	0.5	4	1	
4.97	●		SSR 04970JS	76	6	40	12	0.5	4	1	
4.98	●		SSR 04980JS	76	6	40	12	0.5	4	1	
4.99	●		SSR 04990JS	76	6	40	12	0.5	4	1	
5.00	+0.005 0		●	SSR 05000JS	76	6	40	12	0.5	4	1
5.01			●	SSR 05010JS	76	6	40	12	0.5	4	1
5.02		●	SSR 05020JS	76	6	40	12	0.5	4	1	
5.03		●	SSR 05030JS	76	6	40	12	0.5	4	1	
5.97		●	SSR 05970JS	76	7	40	16	1.0	4	1	
5.98		●	SSR 05980JS	76	7	40	16	1.0	4	1	
5.99		●	SSR 05990JS	76	7	40	16	1.0	4	1	
6.00		+0.005 0	●	SSR 06000JS	76	7	40	16	1.0	4	1
6.01			●	SSR 06010JS	76	7	40	16	1.0	4	1
6.02	●		SSR 06020JS	76	7	40	16	1.0	4	1	
6.03	●		SSR 06030JS	76	7	40	16	1.0	4	1	
6.97	●		SSR 06970JS	101	8	65	16	1.0	6	1	
6.98	●		SSR 06980JS	101	8	65	16	1.0	6	1	
6.99	●	SSR 06990JS	101	8	65	16	1.0	6	1		
7.00	+0.005 0	●	SSR 07000JS	101	8	65	16	1.0	6	1	
7.01		●	SSR 07010JS	101	8	65	16	1.0	6	1	
7.02		●	SSR 07020JS	101	8	65	16	1.0	6	1	
7.03		●	SSR 07030JS	101	8	65	16	1.0	6	1	
7.97		●	SSR 07970JS	101	9	65	19	1.0	6	1	
7.98		●	SSR 07980JS	101	9	65	19	1.0	6	1	
7.99	●	SSR 07990JS	101	9	65	19	1.0	6	1		
8.00	+0.005 0	●	SSR 08000JS	101	9	65	19	1.0	6	1	
8.01		●	SSR 08010JS	101	9	65	19	1.0	6	1	
8.02		●	SSR 08020JS	101	9	65	19	1.0	6	1	
8.03		●	SSR 08030JS	101	9	65	19	1.0	6	1	
8.97		●	SSR 08970JS	101	10	65	19	1.0	6	1	
8.98		●	SSR 08980JS	101	10	65	19	1.0	6	1	
8.99		●	SSR 08990JS	101	10	65	19	1.0	6	1	

Grade: ACR40

■ Diameter ø9.00 to 12.00mm

Diameter DC (mm)	Diameter Tolerance (mm)	Stock	Cat. No.	Dimensions (mm)					Number of Teeth	Fig	
				Overall Length OAL	Shank Dia. DCON	Neck Length LPR	Cutting Edge Length LH	Engagement Length PL			
9.00	+0.005 0	●	SSR 09000JS	101	10	65	19	1.0	6	1	
9.01		●	SSR 09010JS	101	10	65	19	1.0	6	1	
9.02		●	SSR 09020JS	101	10	65	19	1.0	6	1	
9.03		●	SSR 09030JS	101	10	65	19	1.0	6	1	
9.97		●	SSR 09970JS	130	11	85	22	1.0	6	1	
9.98		●	SSR 09980JS	130	11	85	22	1.0	6	1	
9.99		●	SSR 09990JS	130	11	85	22	1.0	6	1	
10.00		+0.005 0	●	SSR 10000JS	130	11	85	22	1.0	6	1
10.01			●	SSR 10010JS	130	11	85	22	1.0	6	1
10.02	●		SSR 10020JS	130	11	85	22	1.0	6	1	
10.03	●		SSR 10030JS	130	11	85	22	1.0	6	1	
10.97	●		SSR 10970JS	130	12	85	22	1.0	6	1	
10.98	●		SSR 10980JS	130	12	85	22	1.0	6	1	
10.99	●	SSR 10990JS	130	12	85	22	1.0	6	1		
11.00	+0.005 0	●	SSR 11000JS	130	12	85	22	1.0	6	1	
11.01		●	SSR 11010JS	130	12	85	22	1.0	6	1	
11.02		●	SSR 11020JS	130	12	85	22	1.0	6	1	
11.03		●	SSR 11030JS	130	12	85	22	1.0	6	1	
11.97		●	SSR 11970JS	130	13	85	22	1.0	6	1	
11.98		●	SSR 11980JS	130	13	85	22	1.0	6	1	
11.99		●	SSR 11990JS	130	13	85	22	1.0	6	1	
12.00		●	SSR 12000JS	130	13	85	22	1.0	6	1	

Grade: ACR40

Recommended Cutting Conditions **P8**

■ Identification Code

SSR 03500 JS

Series

Dia.

For Blind Holes

● mark: Standard stocked item

Recommended Cutting Conditions

Work Material		Carbon Steel for Mechanical Structures Alloy Steel for Mechanical Structures General Steel for Structures		Cast Iron		Ductile Cast Iron		Hardened Steel Up to 45HRC		Depth of Cut a_p (mm/radius)
Cutting Speed		80 to 180m/min		60 to 140m/min		60 to 180m/min		20 to 60m/min		
Diameter DC (mm)	Number of Teeth	Spindle Speed (min ⁻¹)	Feed Rate (mm/rev)	Spindle Speed (min ⁻¹)	Feed Rate (mm/rev)	Spindle Speed (min ⁻¹)	Feed Rate (mm/rev)	Spindle Speed (min ⁻¹)	Feed Rate (mm/rev)	
∅3	4	8,400-19,100	0.5-0.8	6,300-14,800	0.5-0.8	6,300-19,100	0.5-0.8	2,100-6,300	0.12-0.3	0.05-0.075
∅4	4	6,300-14,300	0.5-1.0	4,700-11,100	0.5-1.0	4,700-14,300	0.5-1.0	1,500-4,700	0.16-0.3	
∅5	4	5,000-11,400	0.6-1.0	3,800-8,900	0.6-1.0	3,800-11,400	0.6-1.0	1,200-3,800	0.16-0.4	
∅6	4	4,200-9,500	0.6-1.0	3,100-7,400	0.6-1.0	3,100-9,500	0.6-1.0	1,000-3,100	0.2-0.4	
∅7	6	3,600-8,100	0.6-1.8	2,700-6,300	0.6-1.8	2,700-8,100	0.6-1.8	900-2,700	0.25-0.6	0.05-0.10
∅8	6	3,100-7,100	0.6-1.8	2,300-5,500	0.6-1.8	2,300-7,100	0.6-1.8	800-2,300	0.25-0.6	
∅9	6	2,800-6,300	0.6-1.8	2,100-4,900	0.6-1.8	2,100-6,300	0.6-1.8	700-2,100	0.3-0.6	
∅10	6	2,500-5,700	0.6-1.8	1,900-4,400	0.6-1.8	1,900-5,700	0.6-1.8	630-1,900	0.3-0.6	
∅11	6	2,300-5,200	0.6-2.0	1,700-4,000	0.6-2.0	1,700-5,200	0.6-2.0	570-1,700	0.3-0.8	0.10-0.15
∅12	6	2,100-4,700	0.6-2.0	1,500-3,700	0.6-2.0	1,500-4,700	0.6-2.0	530-1,500	0.3-0.8	

1. The recommended conditions above are for cases where a water soluble coolant is used.
2. Supply sufficient water soluble coolant to the cutting edge.

3. When performing intermittent reaming, reduce the feed rate for the interrupted portion by about 30%.
4. Use with external coolant supply is also possible, but chip evacuation may suffer.

Precautions for Use

● Runout

Machining with poor runout negatively affects hole accuracy and tool life.

Mount with a high-accuracy arbor and collet, etc., in order to minimize cutting edge runout as far as possible. (10 μ m or less is required.)

An arbor with hydraulic chuck, shrink-fit, and runout adjustment mechanism is recommended.

● Applicable Hole Shapes

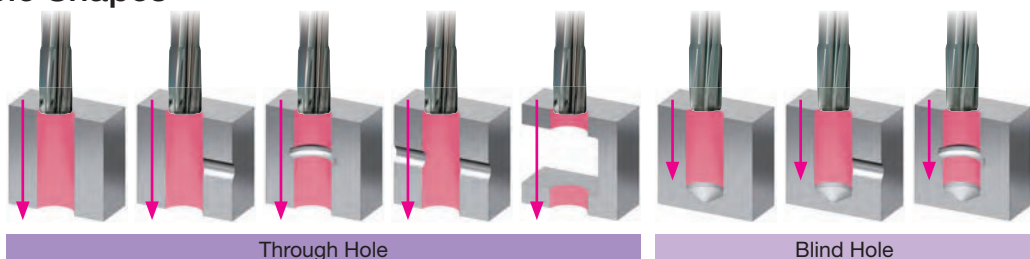

*There is no bottom cutting edge, so bottom finishing is not possible.

● Coolant

Internal coolant supply is recommended.

We recommend coolant pressure of 1.5MPa or higher, for chip evacuation purposes.

Use with external coolant supply may reduce chip evacuation performance and damage machined surface quality.

● Compound Holes

When reaming blind holes connected to through holes, use the through hole type reamers. (Blind hole type not usable)

Also check that the process creates no problems with chip evacuation performance.



Blind hole type not usable

■ Troubleshooting

Failure	Countermeasures
Enlarged hole	<ul style="list-style-type: none"> · Reduce runout as much as possible. (Use arbor with hydraulic chuck, shrink-fit, and runout adjustment mechanism) · Decrease cutting speed. · Increase feed rate. · Reduce stock removal. · Check cutting edge for damage. · Change blade diameter. · Increase coolant concentration.
Tapered hole	<ul style="list-style-type: none"> · Reduce runout as much as possible. (Use arbor with hydraulic chuck, shrink-fit, and runout adjustment mechanism) · Decrease cutting speed. · Reduce feed rate. · Review pre-reaming process. (Prepared hole deviation) · Review workpiece clamping method. · Compare hole diameters when the workpiece is clamped and unclamped. · Correct chip evacuation. (Increase coolant pressure) · Adjust coolant concentration.
Chatter marks on machined surface	<ul style="list-style-type: none"> · Reduce runout as much as possible. (Use arbor with hydraulic chuck, shrink-fit, and runout adjustment mechanism) · Decrease cutting speed. · Increase feed rate. · Review workpiece clamping method. · Change cutting edge approach angle to a made-to-order design.
Poor surface finish roughness	<ul style="list-style-type: none"> · Reduce runout as much as possible. (Use arbor with hydraulic chuck, shrink-fit, and runout adjustment mechanism) · Increase cutting speed. · Check cutting edge for damage. · Check whether cutting conditions are within the recommended range. · Increase coolant concentration.
Return mark	<ul style="list-style-type: none"> · Reduce runout as much as possible. (Use arbor with hydraulic chuck, shrink-fit, and runout adjustment mechanism) · Check cutting edge for damage. · Reduce stock removal. · Decrease return rate after machining.
Abnormal cutting noise	<ul style="list-style-type: none"> · Check cutting edge for damage. · Increase the stock removal. · Decrease the coolant concentration. · Change cutting edge approach angle to a made-to-order design.
Work diameter is reduced.	<ul style="list-style-type: none"> · Increase cutting speed. · Reduce feed rate. · Check cutting edge for damage. · Increase the stock removal. · Decrease the coolant concentration.

SumiReamer SSR series Made-To-Order Request Sheet

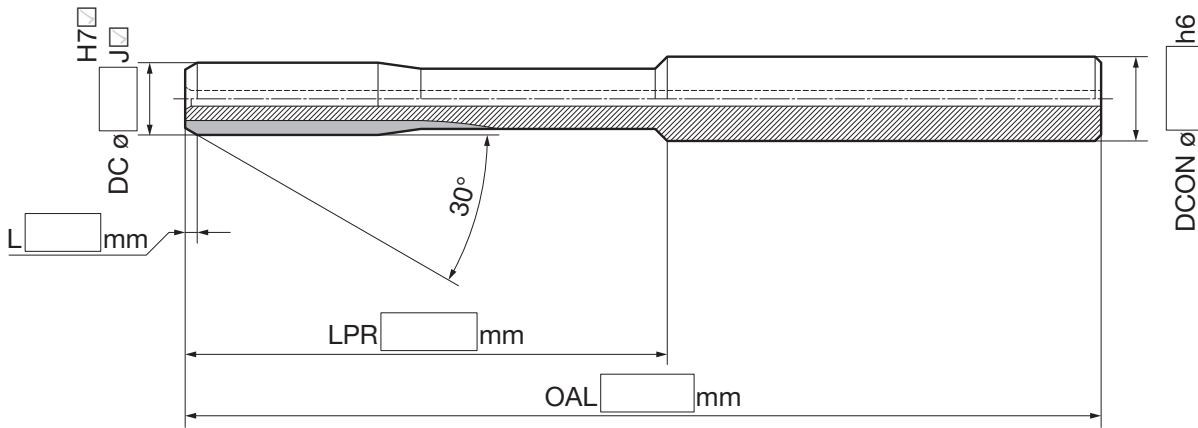

Equipment Information

Manufacturer: _____

Type: MC NC Lathe Multi-task Machine

Tool Folder: BT HSK Other

Coolant: Water-soluble Oil-based MQL

Coolant Supply: Internal Coolant Supply External Coolant Supply

Workpiece Shape

Workpiece Information

Part Name: _____

Work Material: _____

Work Material Hardness: _____

Hole Type: Through Hole Blind Hole

Interrupted Cutting: Yes No

Hole Depth: _____

Required Precision

Hole Dia. Tolerance: _____

Surface Roughness: _____

Circularity: _____

Cylindricity: _____

Other: _____

Current Tool

Number of Teeth: _____

Cutting Conditions: $v_c =$ _____ m/min $f =$ _____ mm/rev $a_p =$ _____ mm

Tool Life: _____

Tool Life Criteria: _____

After filling in the required dimensions and other information, contact our nearest sales office or distributor.

Feel free to contact us with other requests as well.

Company Name/Contact

Remarks

MEMO

A large grid of dotted lines for writing a memo. The grid consists of 20 columns and 30 rows of small squares, providing a structured space for text entry.

Application Examples

Steel S45C Automotive Component		Sumitomo	Comp's
 <p>Horizontal Machining Centre</p> <p>Required Precision Hole Dia.: $\phi 7^{+0.020}_0$ (Reaming depth: 23mm) Surface Roughness: Ra 1.0μm</p>	Reamer Dia. (mm)	7	7
	Number of Teeth	6	3
	V_c (m/min)	110	50
	f (mm/rev)	0.55	0.36
	V_f (mm/min)	2,752	819
	a_p (mm)	0.05	0.15
	Coolant	Wet	Wet
	Results	3x or more machining efficiency, 4x tool life achieved	

Cast Iron FCV420 Hydraulic Component		Sumitomo	Comp's
 <p>Vertical Machining Centre</p> <p>Required Precision Hole Dia.: $\phi 11^{+0.018}_0$ (Reaming depth: 15mm) Surface Roughness: Ra 1.6μm</p>	Reamer Dia. (mm)	11	11
	Number of Teeth	6	6
	V_c (m/min)	110	15
	f (mm/rev)	0.66	0.12
	V_f (mm/min)	2,101	52
	a_p (mm)	0.1	0.1
	Coolant	Wet	Wet
	Results	40x or more machining efficiency, 2.3x tool life achieved Machining cycle time reduced from 17.3 seconds to 0.4 seconds	

Steel S45C Automotive Component		Sumitomo	Comp's
 <p>NC Lathe</p> <p>Required Precision Hole Dia.: $\phi 5.5^{+0.030}_0$ (Reaming depth: 35mm) Surface Roughness: Rz 6.3μm</p>	Reamer Dia. (mm)	5.5	5.5
	Number of Teeth	4	4
	V_c (m/min)	90	90
	f (mm/rev)	1.0	1.0
	V_f (mm/min)	5,211	5,211
	a_p (mm)	0.1	0.1
	Coolant	Wet	Wet
	Results	Tool life doubled	

Steel SCM440 (45HRC) Automotive Component		Sumitomo	Comp's
 <p>NC Lathe</p> <p>Required Precision Hole Dia.: $\phi 8^{+0.030}_0$ (Reaming depth: 33mm) Surface Roughness: Ra 1.6μm</p>	Reamer Dia. (mm)	8	8
	Number of Teeth	6	6
	V_c (m/min)	40	20
	f (mm/rev)	0.14	0.09
	V_f (mm/min)	223	72
	a_p (mm)	0.15	0.15
	Coolant	Wet	Wet
	Results	3x or more machining efficiency, 2.9x tool life achieved	

*For diameters of $\phi 12$ mm or larger, use the SumiReamer SR Type. (For details, refer to our brochure.)

< SAFETY NOTES >



- Very hot or lengthy chips may be discharged while the machine is in operation. Therefore, machine guards, safety goggles or other protective covers must be used. Fire safety precautions must also be considered.

- Please handle with care as this product has sharp edges.
- Improper cutting conditions or mis-handling of the tool may result in breakages or projectiles. Therefore, please use the tool within its recommended conditions.

- When using non-water soluble cutting oil, precautions against fire must be taken and please ensure that a fire extinguisher is placed near the machine.

Sumitomo Electric Industries, Ltd.

Hardmetal Division

Global Marketing Department : 1-1-1, Koyakita, Itami, Hyogo 664-0016, Japan

Tel: +81-72-772-4535

Fax: +81-72-771-0088

<https://www.sumitool.com/global>